

2017 CANADIAN NATIVE FASTBALL CHAMPIONSHIPS  
 MEN'S SENIOR DRAW (JOHN FRY - 9700 28 Ave NW, Edmonton, AB )  
 JF-5 = John Fry, Diamond 5 JF-6 = John Fry, Diamond 6 \*MAIN

OVER FLOW DIAMOND - Henry Singer #1 (HS-1)  
 HS-1 - Loser's & Consolation Brackets

\*Money Game is when both teams are guaranteed money.

1st	\$	12,000.00
2nd	\$	7,500.00
3rd	\$	5,000.00
4th	\$	3,000.00
Total Payout		\$ 27,500.00

Consolation Winner \$ 2,000.00



(Winner's bracket)

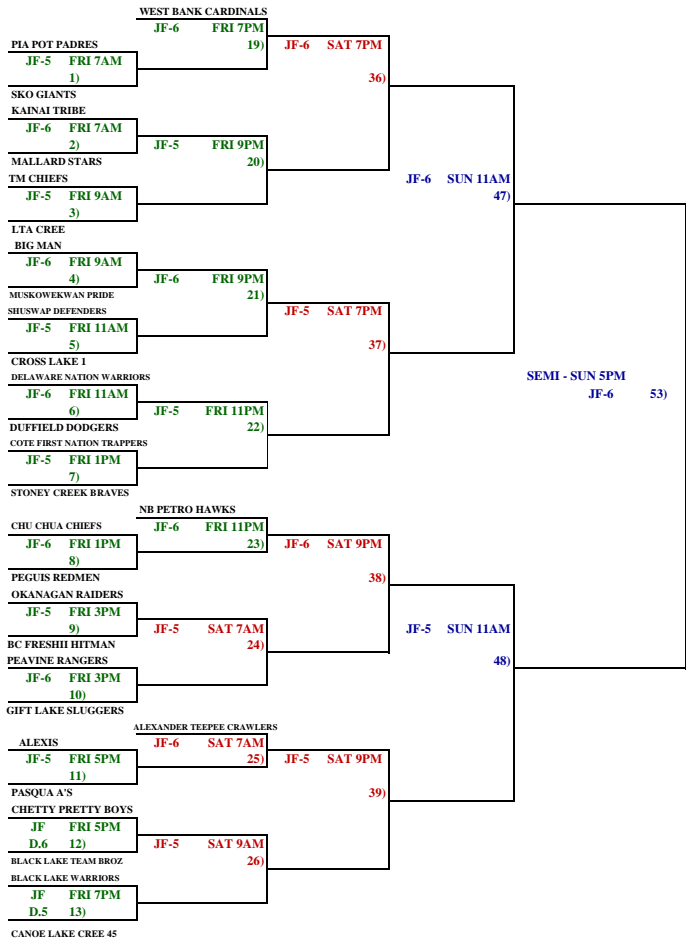

(Loser's bracket)

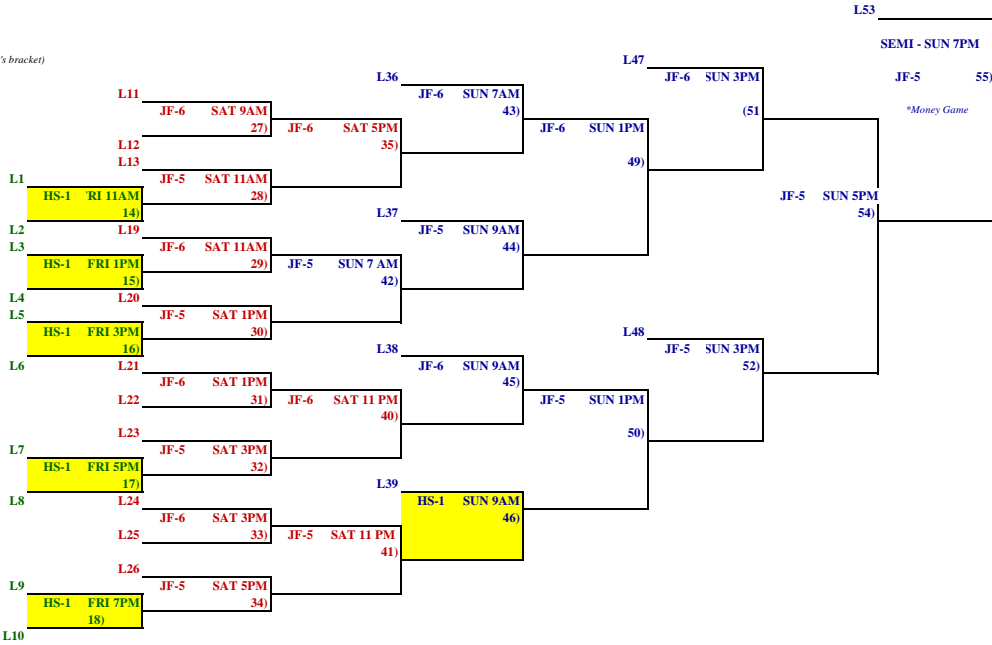

CONSOLATION BRACKET - FOLLOWING LOSERS OF GAMES 1, 2, 3, 4, 5, 6, 7, 8, 9 & 10 ONLY

\*Note - Teams that received a "BI" in either the first and second round do not qualify for playoff.

\*\*\*However, following the teams with BI's (L11, L12, L13, L19, L23, & L25) and two straight losses are asked to contact: Veronica Hayward, Tournament Coordinator for further details at 780-700-1090

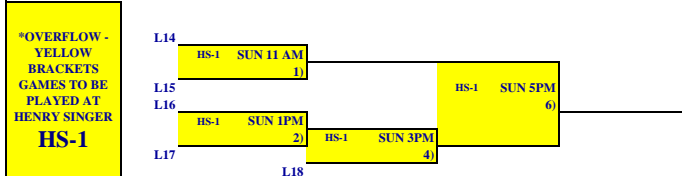

**2017 CANADIAN NATIVE FASTBALL CHAMPIONSHIPS**  
**WOMEN'S SENIOR DRAW** (JOHN FRY - 9700 28 Ave NW, Edmonton, AB )  
**JF-3 = John Fry, Diamond 3      JF-4 = John Fry, Diamond 4 \*MAIN**

**OVER FLOW DIAMOND - Henry Singer #3 (HS-3)**  
**HS-3 Loser's & Consolation Brackets**

(Winner's bracket)

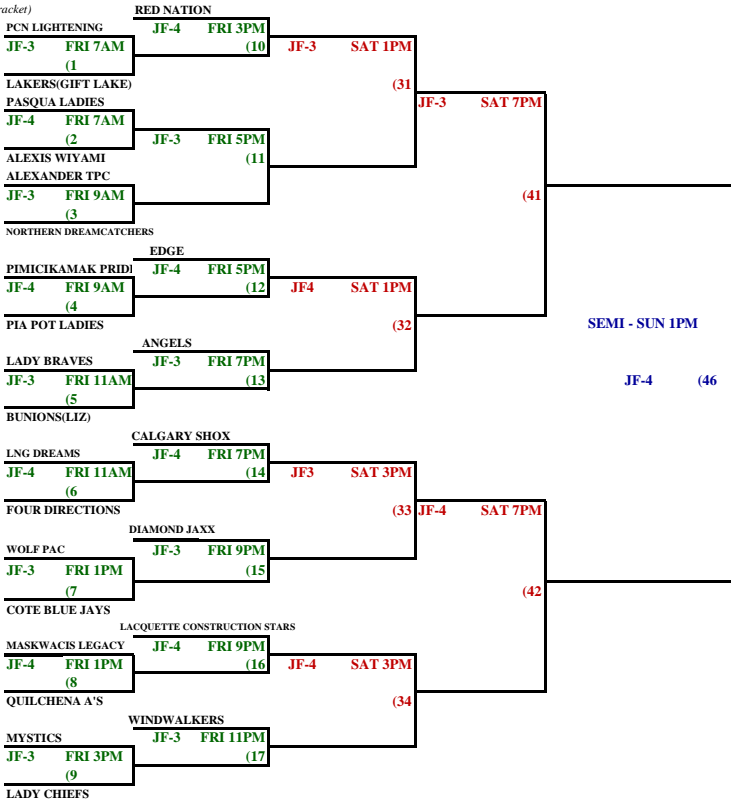

\*Money Game is when both teams are guaranteed money.

1st	\$	10,000.00
2nd	\$	7,500.00
3rd	\$	5,000.00
4th	\$	3,000.00
<b>Total Payout</b>	<b>\$</b>	<b>25,500.00</b>



Consolation Winner \$ 2,000.00

(Loser's bracket)

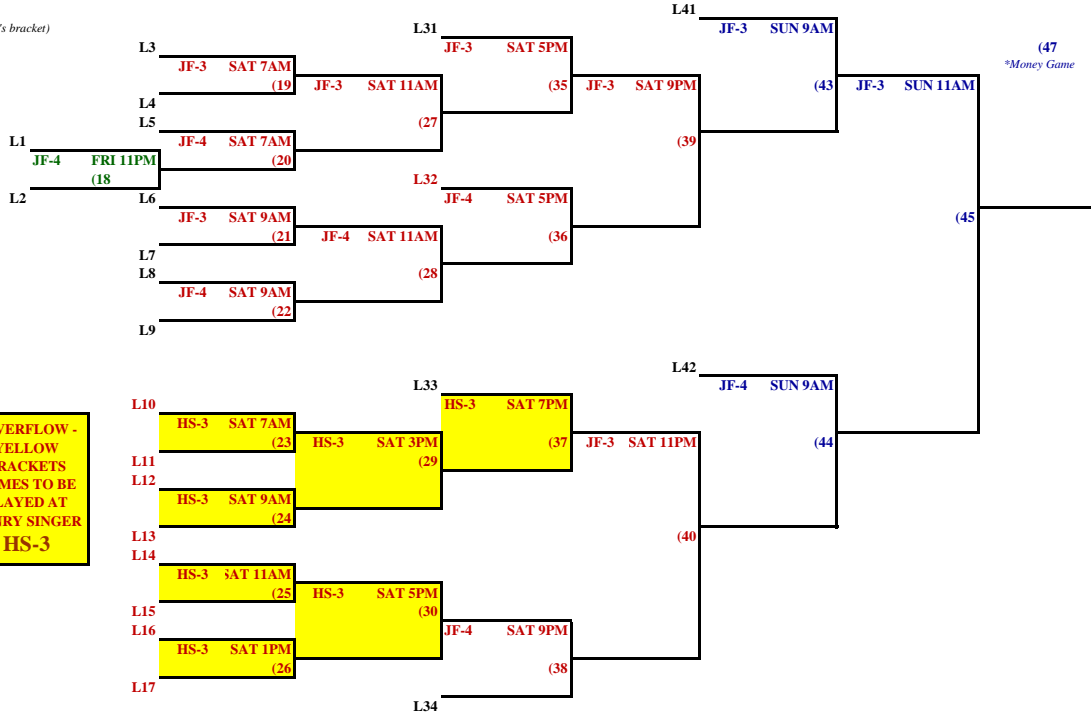

**\*OVERFLOW - YELLOW BRACKETS GAMES TO BE PLAYED AT HENRY SINGER HS-3**



**CONSOLATION BRACKET - FOLLOWING THE LOSERS OF GAMES 1, 2, 3, 4, 5, 6, 7, 8 & 9 ONLY**

\*Note - Teams that received a "BI" in either the first and second round do not qualify for playoff.

\*\*\*However, following teams with BI's (L10, L11, L12, L13, L14, L15, L16 & L17) and two straight losses are asked to contact: Veronica Hayward, Tournament Coordinator for further details at 780-700-1090

**\*OVERFLOW - YELLOW BRACKETS GAMES TO BE PLAYED AT HENRY SINGER HS-3**

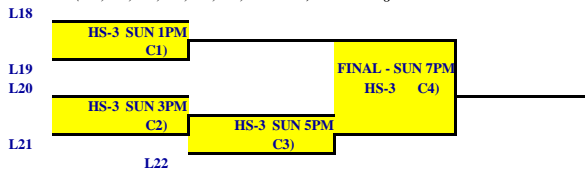

**2017 CANADIAN NATIVE FASTBALL CHAMPIONSHIP**  
**MEN'S MASTER (HENRY SINGER - 14940 - 142 St, Edmonton, Ab)**  
**HS-2 = HENRY SINGER, DIAMOND 2**

**OVER FLOW DIAMOND - Henry Singer #3 (HS -3)**

*\*Money Game is when both teams are guaranteed money.*

1st \$ 6,000.00  
 2nd \$ 4,000.00  
 3rd \$ 2,000.00  
**Total Payout \$ 12,000.00**



*(Winner's bracket)*

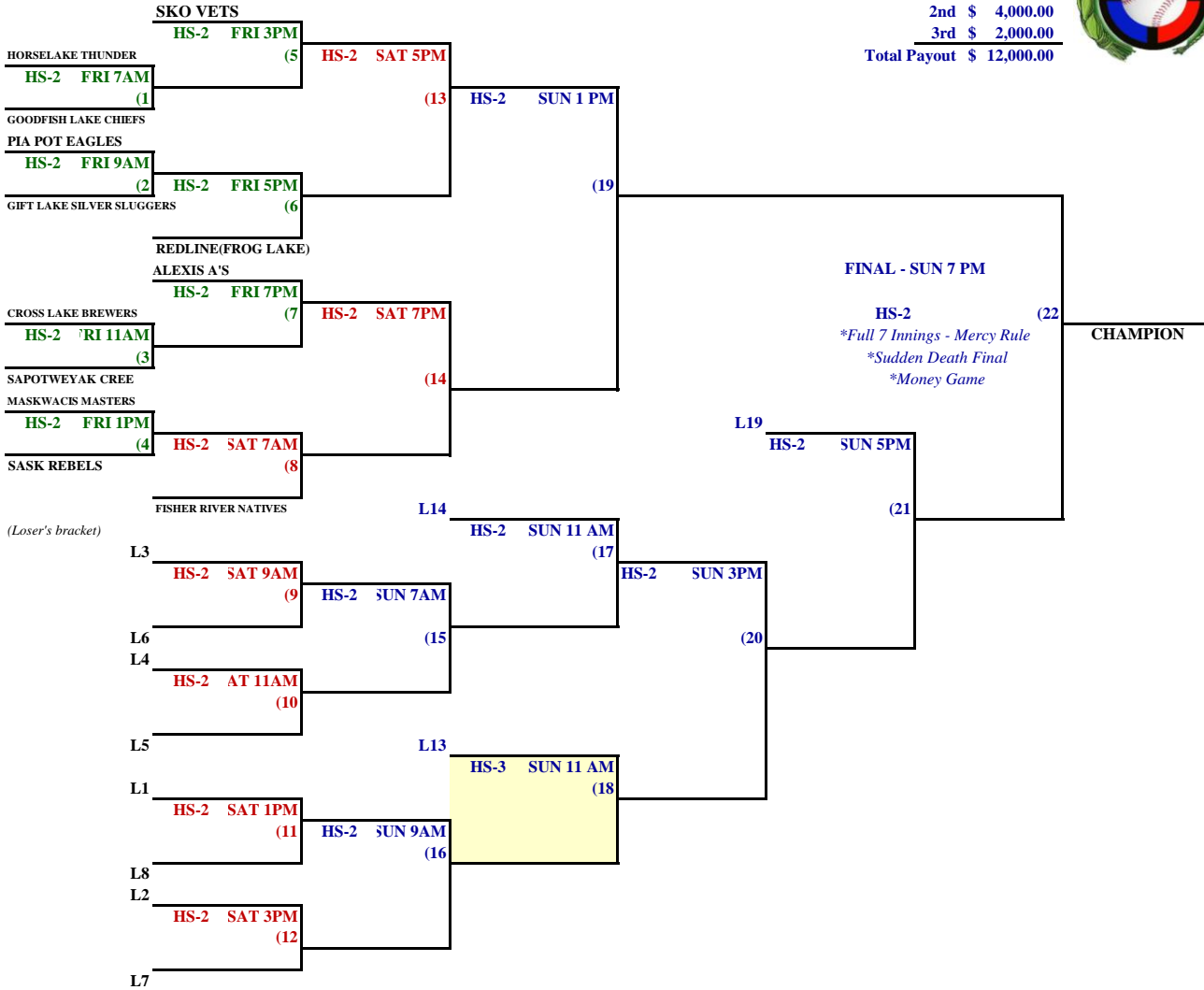

**FINAL - SUN 7 PM**

**HS-2 (22)**  
*\*Full 7 Innings - Mercy Rule*  
*\*Sudden Death Final*  
*\*Money Game*

**CHAMPION**

**2017 CANADIAN NATIVE FASTBALL CHAMPIONSHIP**

**WOMEN'S MASTER DRAW (HENRY SINGER PARK - 14940 - 142 St, Edmonton, Ab)**

**HS-3= HENRY SINGER, DIAMOND 3**

*\*Money Game is when both teams are guaranteed money.*

1st	\$ 5,000.00
2nd	\$ 2,500.00
3rd	\$ 1,500.00
<b>Total Payout</b>	<b>\$ 9,000.00</b>



*(Winner's bracket)*

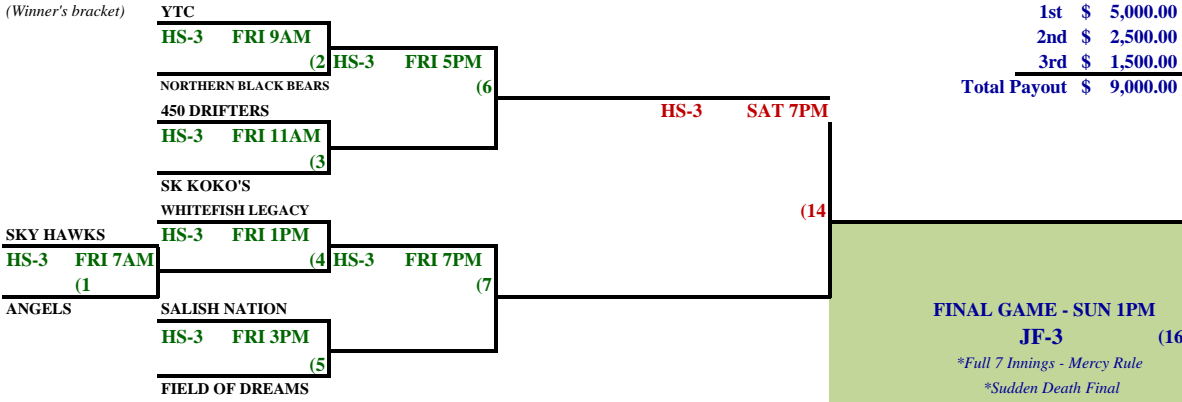

*(Loser's bracket)*

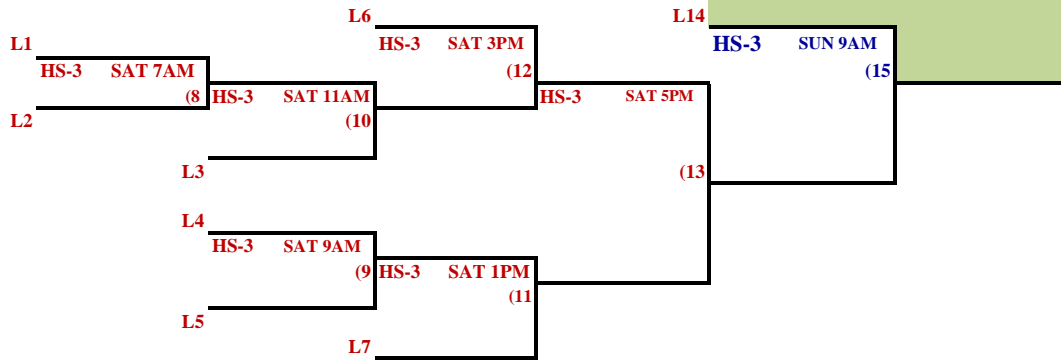

**2017 CANADIAN NATIVE FASTBALL CHAMPIONSHIP**  
**JUNIOR MEN'S DRAW (HENRY SINGER - 14940 - 142 St, Edmonton, Ab)**  
**HS-4 = HENRY SINGER, DIAMOND 4**

*\*Money Game is when both teams are guaranteed money.*

1st	\$ 5,000.00
2nd	\$ 4,000.00
3rd	\$ 2,000.00
<b>Total Payout</b>	<b>\$ 11,000.00</b>



*(Winner's bracket)*

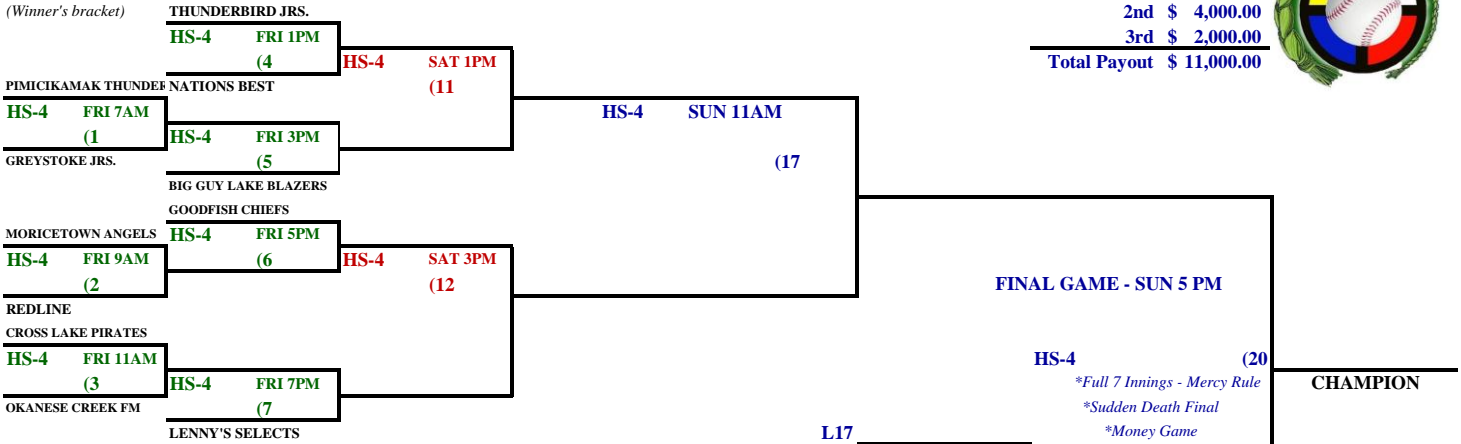

*(Loser's bracket)*

